

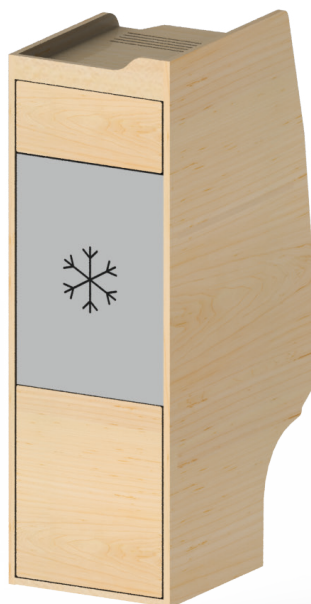

Notice de montage

Colonne haute

Colonne haute



Outils nécessaires



Inclus dans votre kit Exokit

Kit fixation meuble



x1

4,80x60 autoforante



x1

4x15 tête fraisée



x12

3,5x16 tête bombée



x2

équerre en métal



x4

3,9x25 autoforante

Kit fixation meuble



x1

loqueteau



x2

4x25 tête bombée



x1

3,5x16 tête fraisée



x2

charnières et embases



x1

Gabarit loqueteau

Kit tiroirs



x1

paires de coulisse



x4

vis euro



x4

3,5x12 tête bombée



x1

paire d'accouplement

+ 2 côtés de tiroirs, 1 arrière et 1 fond

Systeme de fixation fourni



1

Joue A



2



3



4

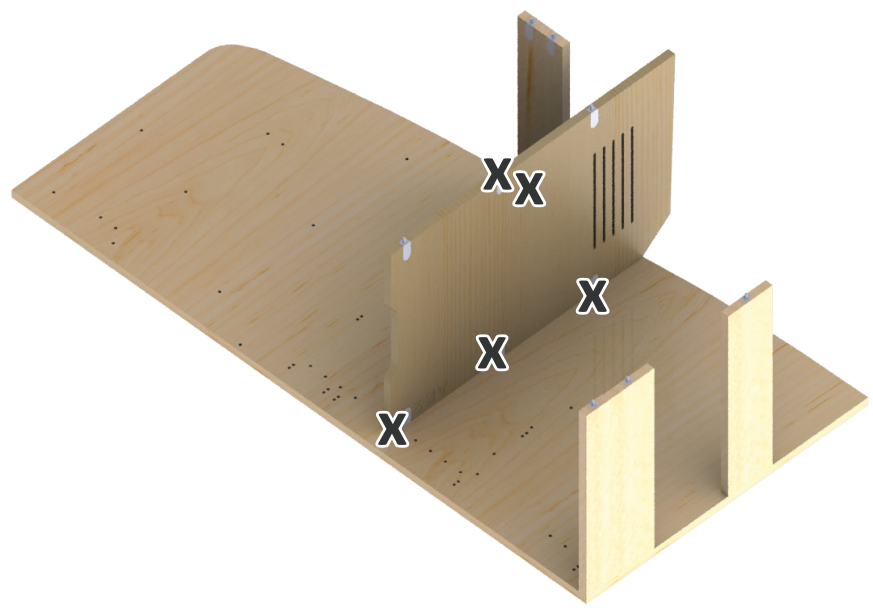

6

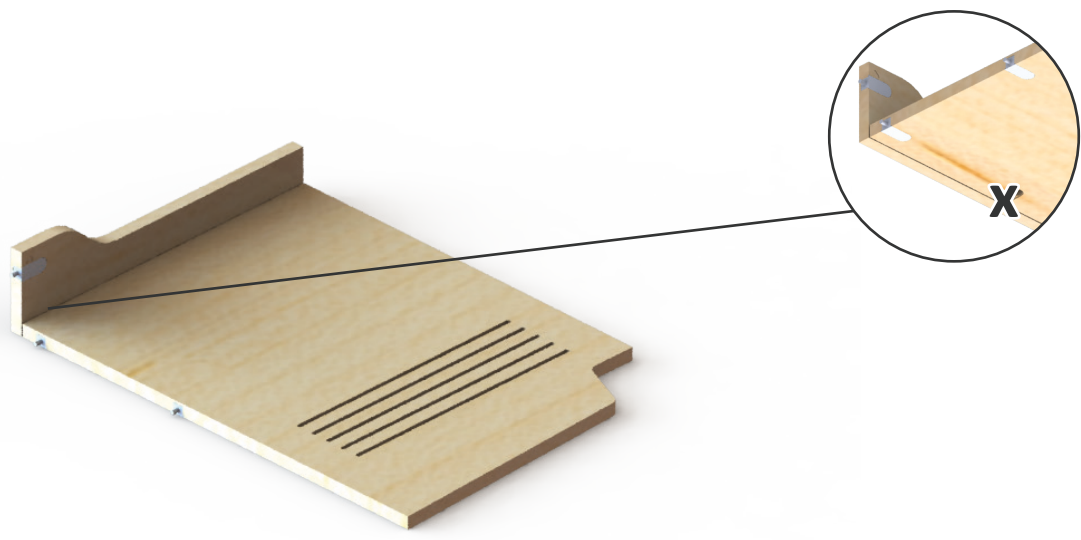

7

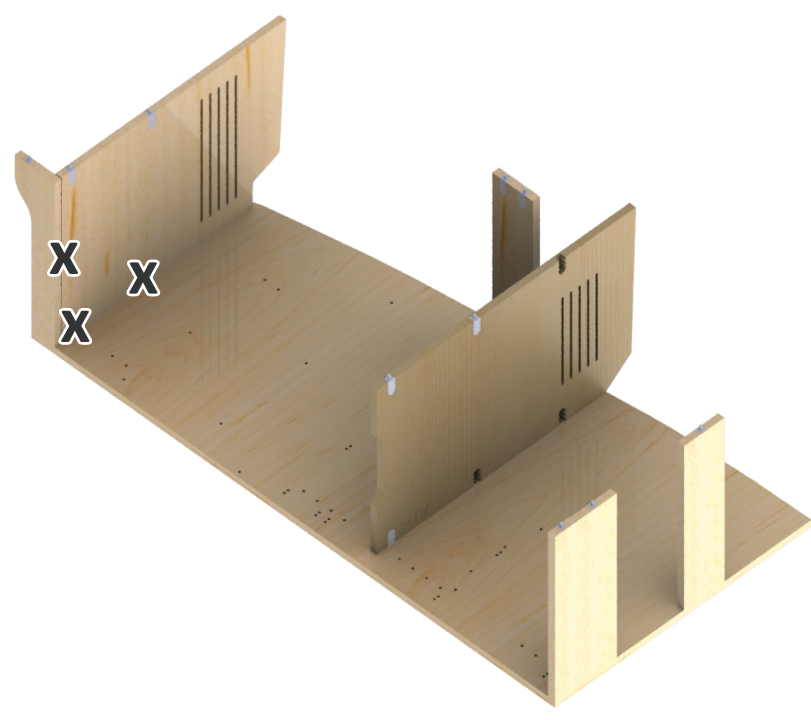

8



9



i Explication fixation façades

vis 4x16 tête bombée pour fixer les loqueteaux (x2 vis par loqueteau)
vis 4x25 tête fraisée pour fixer la pate blanche (1x par pate)

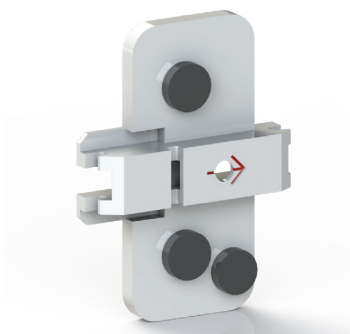

fixer l'embase de la charnière sur la joue, la flèche doit être tournée vers l'avant du meuble.



Utiliser le gabarit clic-clic pour installer le loqueteau à la bonne distance du bord de la joue





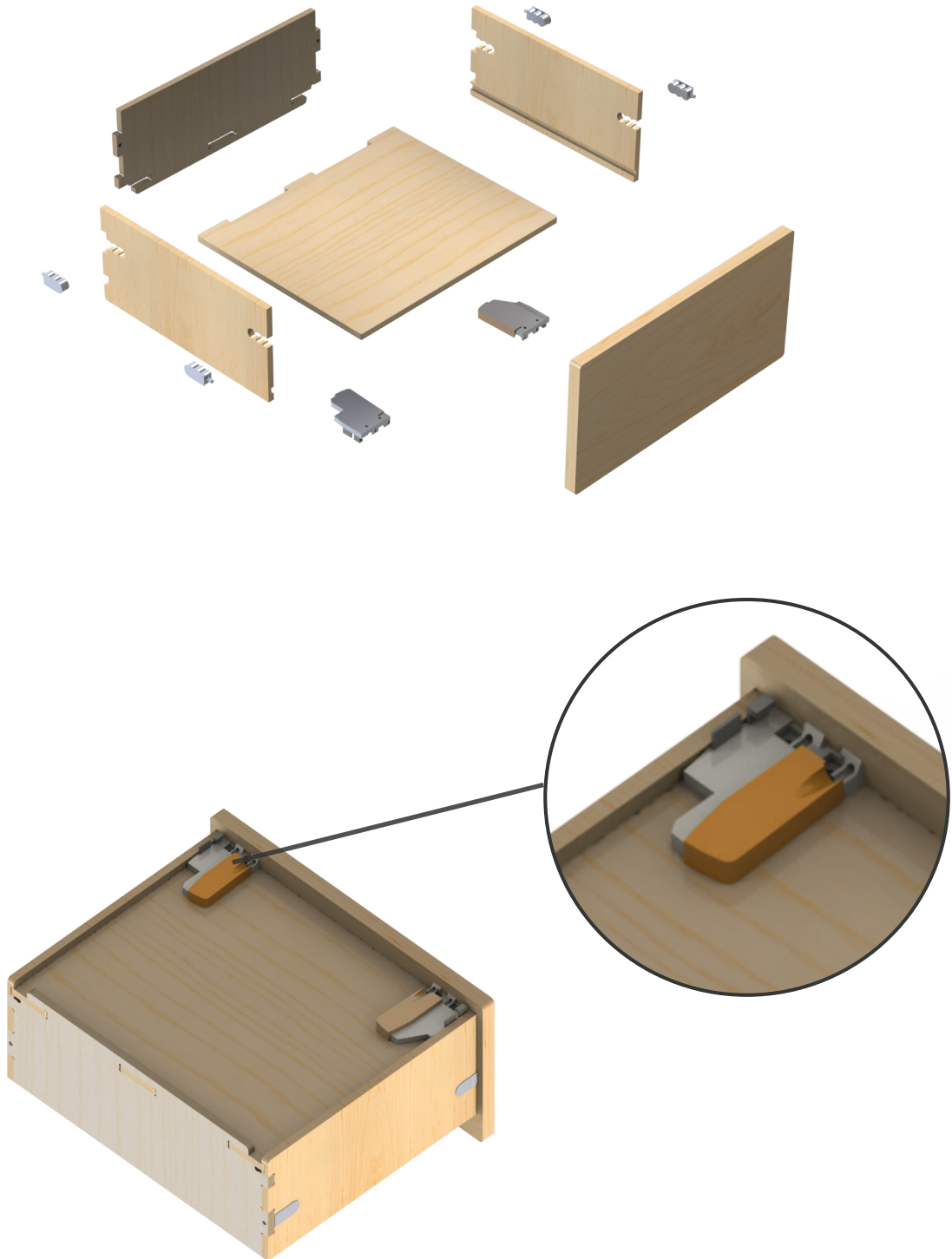

Explication assemblage tiroir avec le **kit tiroir**

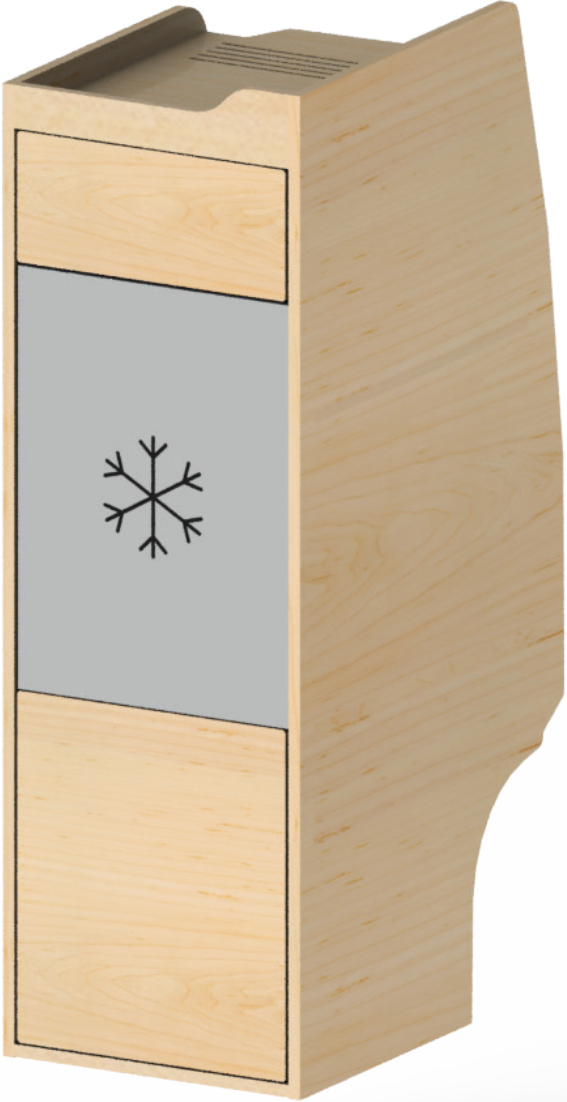

Viser en biais avec 2 vis 4x12 têtes bombées dans les trous prévus à cet effet.



**Pour toutes questions n'hésitez pas
à nous contacter :**

 10 Quai Armez 22000 Saint-Brieuc

 02 90 90 18 42

 contact@exokit-van.com

 [@exokit_van](#)

 [Exokit-van](#)





 [Exokit van](#)

 [exokit-van.com](#)

 [Exokit van](#)



Prix révisable sans préavis. Photos et plans non contractuels - Ré-
production interdite - RCS Saint-Brieuc 8914118998 - Exokit SAS au
capital de 10 000€ - Hello Print

 @exokit_van  Exokit van
 exokit-van.com  Exokit van
 Exokit-van

Votre partenaire :