



Notice de montage

Meuble latéral gauche

Meuble latéral gauche





Notre aménagement avec meuble latéral gauche est le grand classique des aménagements de van. C'est notamment l'implantation qui a fait le succès des fameux combi Volkswagen.

Outils nécessaires

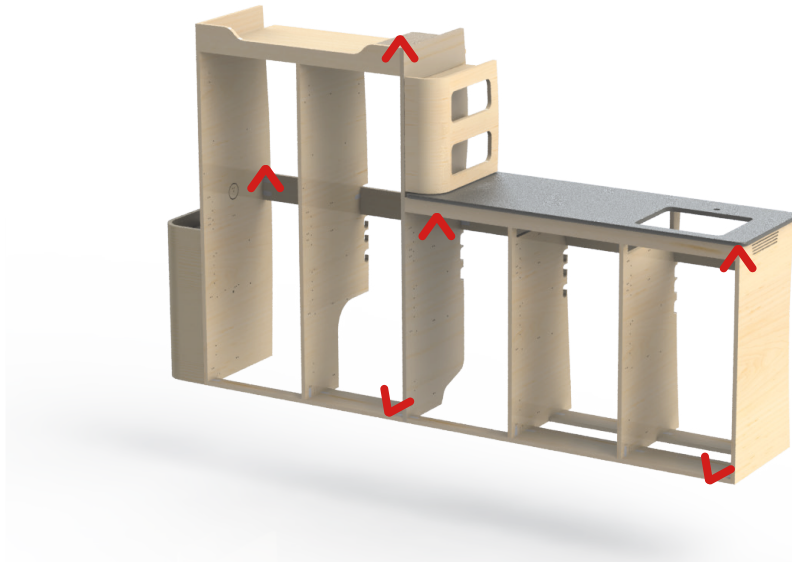

À savoir avant le montage



Les joues de la structures sont toutes gravées de A à G en partant de l'arrière du véhicule. La structure est divisée en colonnes de 40cm, soit 5 colonnes (2 hautes et 3 basses) pour un véhicule de 4,90m et 6 colonnes pour un véhicule de 5,30m (3 hautes et 3 basses). Les flèches  doivent se trouver dans les zones en rouge sur le dessin ci-dessus. Celles-ci pointent soit vers le haut soit vers l'intérieur du véhicule. Les bandes avec un trait bleu sont les même sur les véhicules de 5,30m. Sur les véhicule de 4,90m la barre basse à la base des colonnes haute est plus courte de 40cm. Le vide poche arrière arrondi est différent d'un véhicule à l'autre, car il permet de faire le complément du meuble jusqu'aux portes arrières.

Système de fixation fourni



Inclus dans votre kit Exokit

Kit 3 portes



x3

loqueteau



x6

4x25 tête bombée



x3

3,5x16 tête fraisée



x6

charnières et embases



x1

Gabarit loqueteau

Kit 3 tiroirs



x3

paires de coulisse



x12

vis euro



x24

3,5x12 tête bombée



x3

paires d'accouplement

+ 7 côtés de tiroirs, 3 arrières et 3 fonds

Kit 3 rideaux



x2

Rideau 22U



x1

Rideau 16U



x18

4x25 tête bombée

Attention des variations peuvent avoir lieu selon le véhicule

Kit plan de travail



x12

4x13 tête fraisée



x6

équerre plastique

Kit imposte



x4

loqueteau façade fixe



x8

4x25 tête bombée



x8

3,5x12 tête bombée

Kit table



x8

4x13 tête fraisée



x7

4x16 tête fraisée



x4

4x25 tête fraisée



x1

barre de soutien/
pied de table



x1

plateau table

Kit fixation meuble



x3

vis autoforante



x5

4x25 tête fraisée



x1

vis papillon et insert

Attention des variations peuvent avoir lieu selon le véhicule

Kit fixation meuble (suite)



x8

4x25 tête bombée



x8

3,5x12 tête bombée

1

Joue A



2



3



Joue C



5



+



Joue B



5



+



6



8

Joue F



9



+

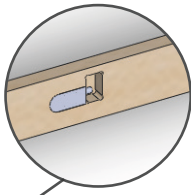

10



Joue D et E



11

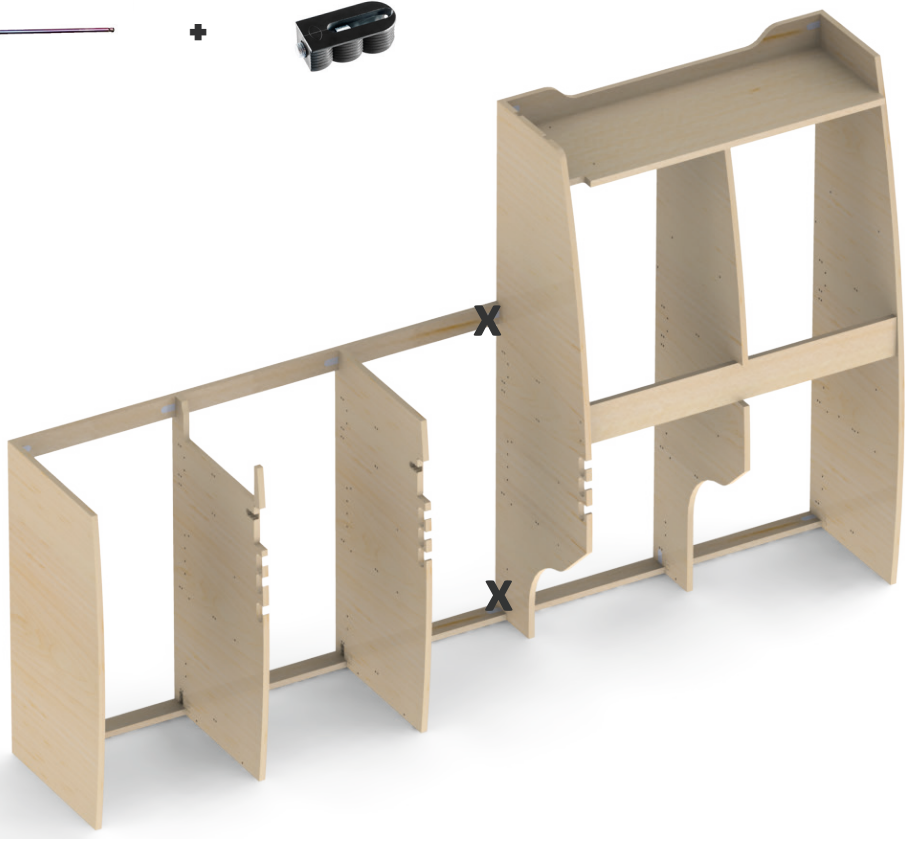

12

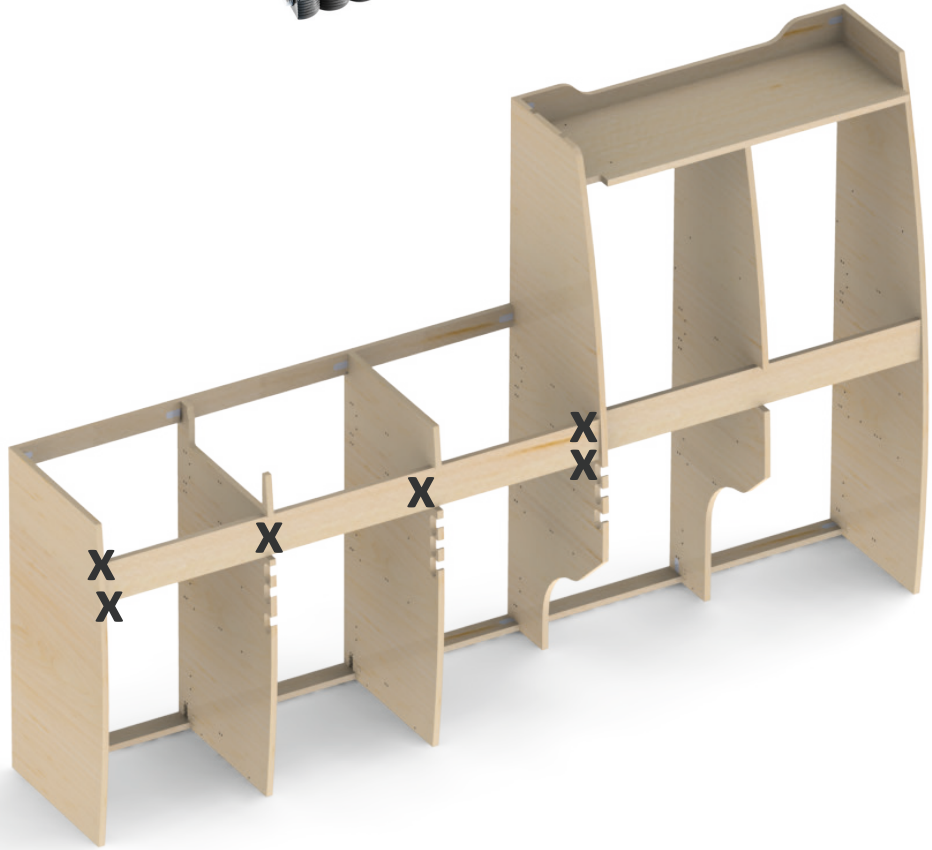

13

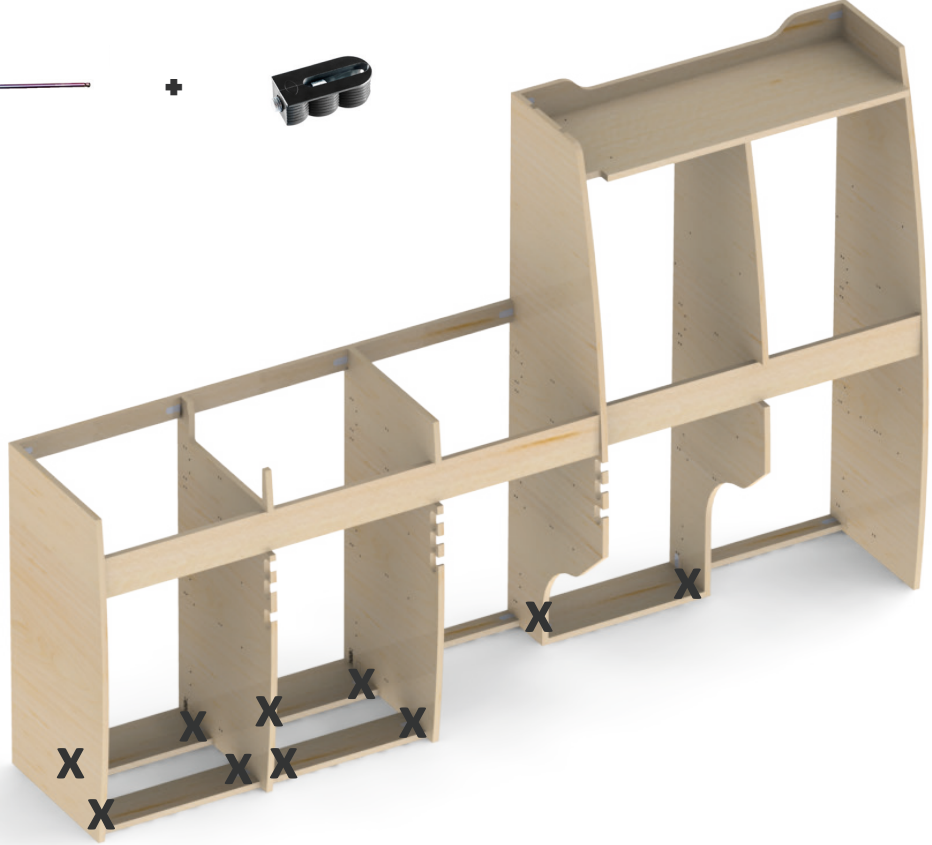

14



Retourner le meuble pour fixer la boîte électrique

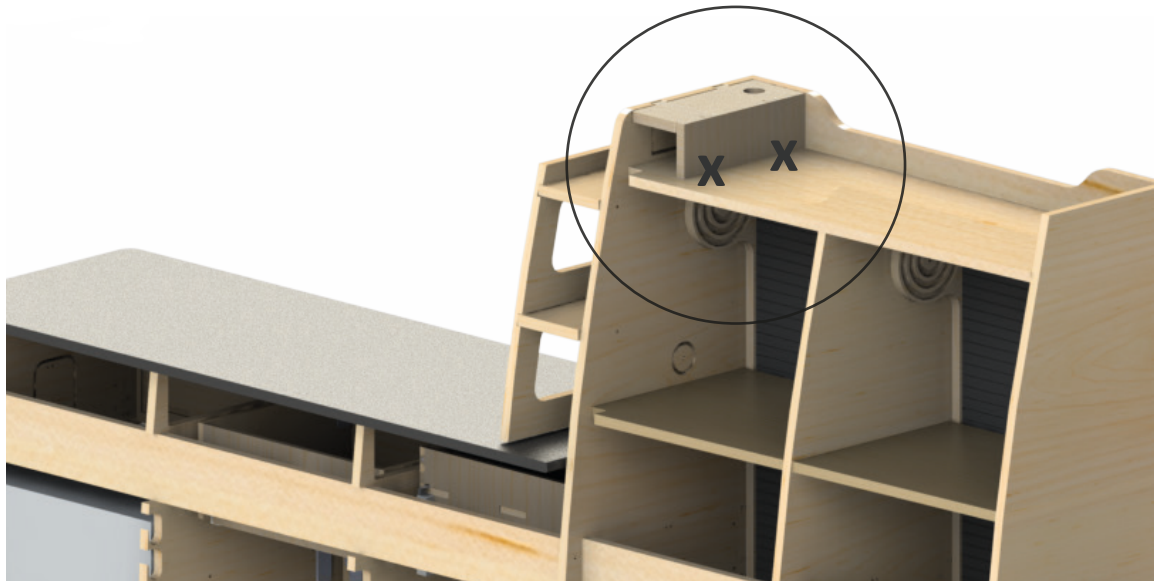

15



N'hésitez pas à dévisser légèrement le cabinéo sur les étagères avant le montage pour éviter les rayures sur les joues

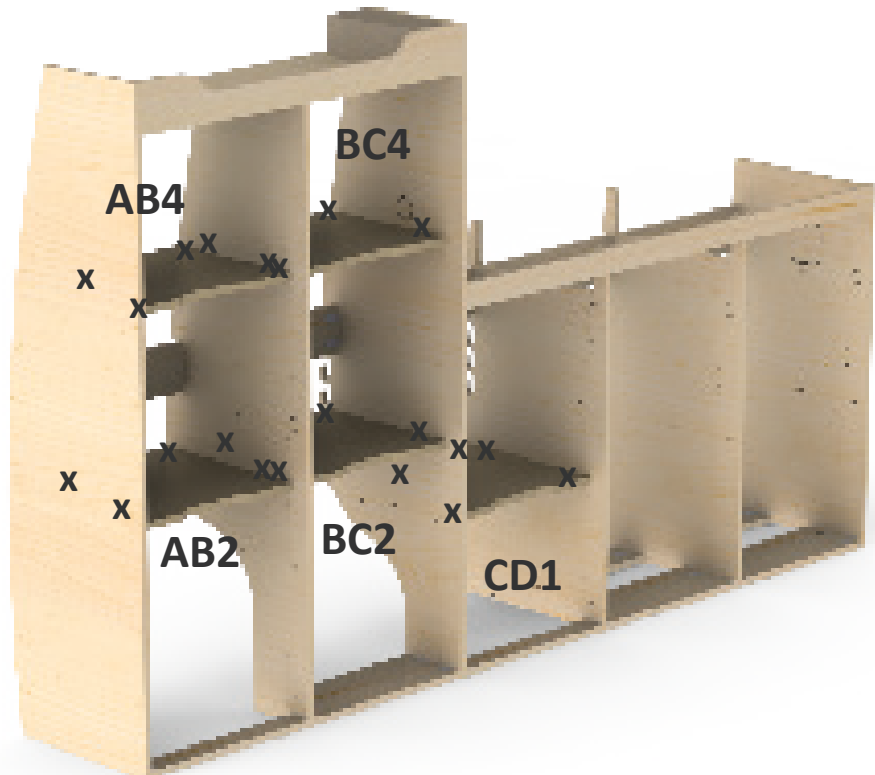

16

Fixer le plan de travail avec le **kit plan de travail** en laissant un débord de 15mm à l'avant le long de la joue F.



17

Fixer les rideaux et les façades avec le **kit 3 portes, 3 rideaux**, et le **kit imposte**



i Explication fixation rideaux

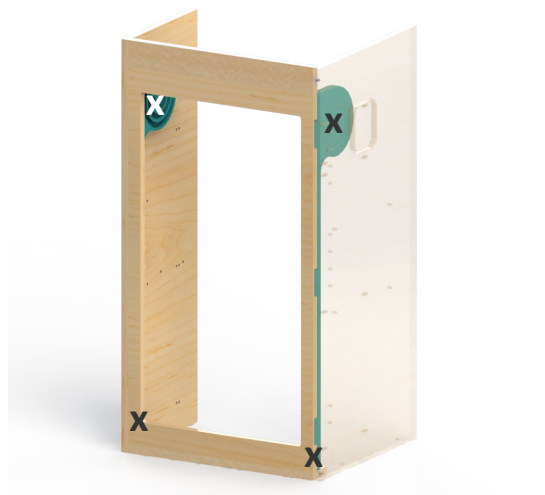

présenter l'assemblage de façon à ce qu'il soit ajusté avec les joues puis fixer les oreilles avec 2 ou 3 vis 4x25



retirer la façade



glisser le rideau par le bas des oreilles



coller la façade avec la colle à bois fournie

i Explication fixation façades

vis 4x16 tête bombée pour fixer les loqueteaux (x2 vis par loqueteau)
vis 4x25 tête fraisée pour fixer la pate blanche (1x par pate)

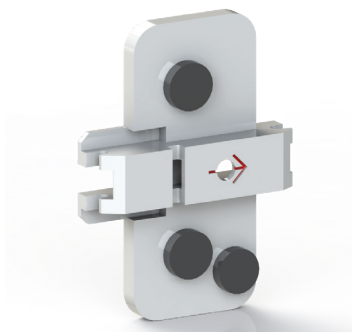

fixer l'embase de la charnière sur la joue, la flèche doit être tournée vers l'avant du meuble.



Utiliser le gabarit clic-clic pour installer le loqueteau à la bonne distance du bord de la joue



18

Fixation vide poche

Percer à travers le pré-perçage dans la joue avec un forêt de 8 mm et insérer l'insert avant de visser les 2 vis papillons

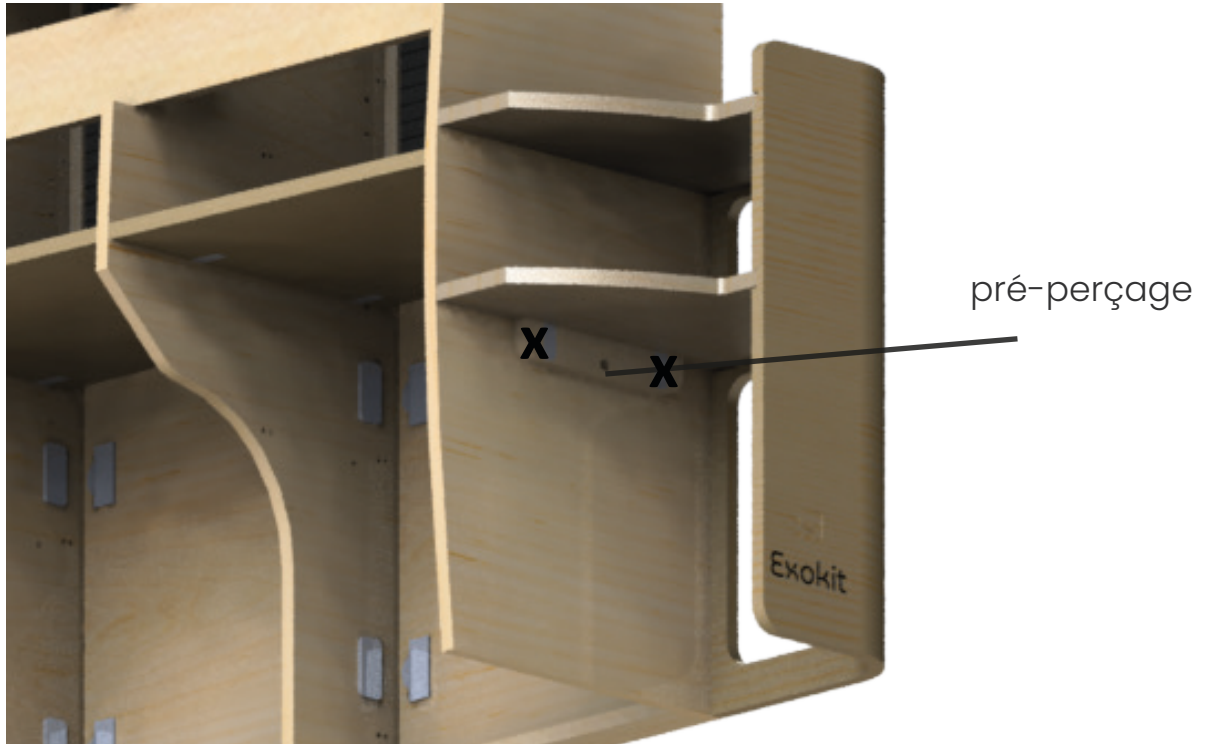

i Explication assemblage tiroir avec le **kit tiroir**

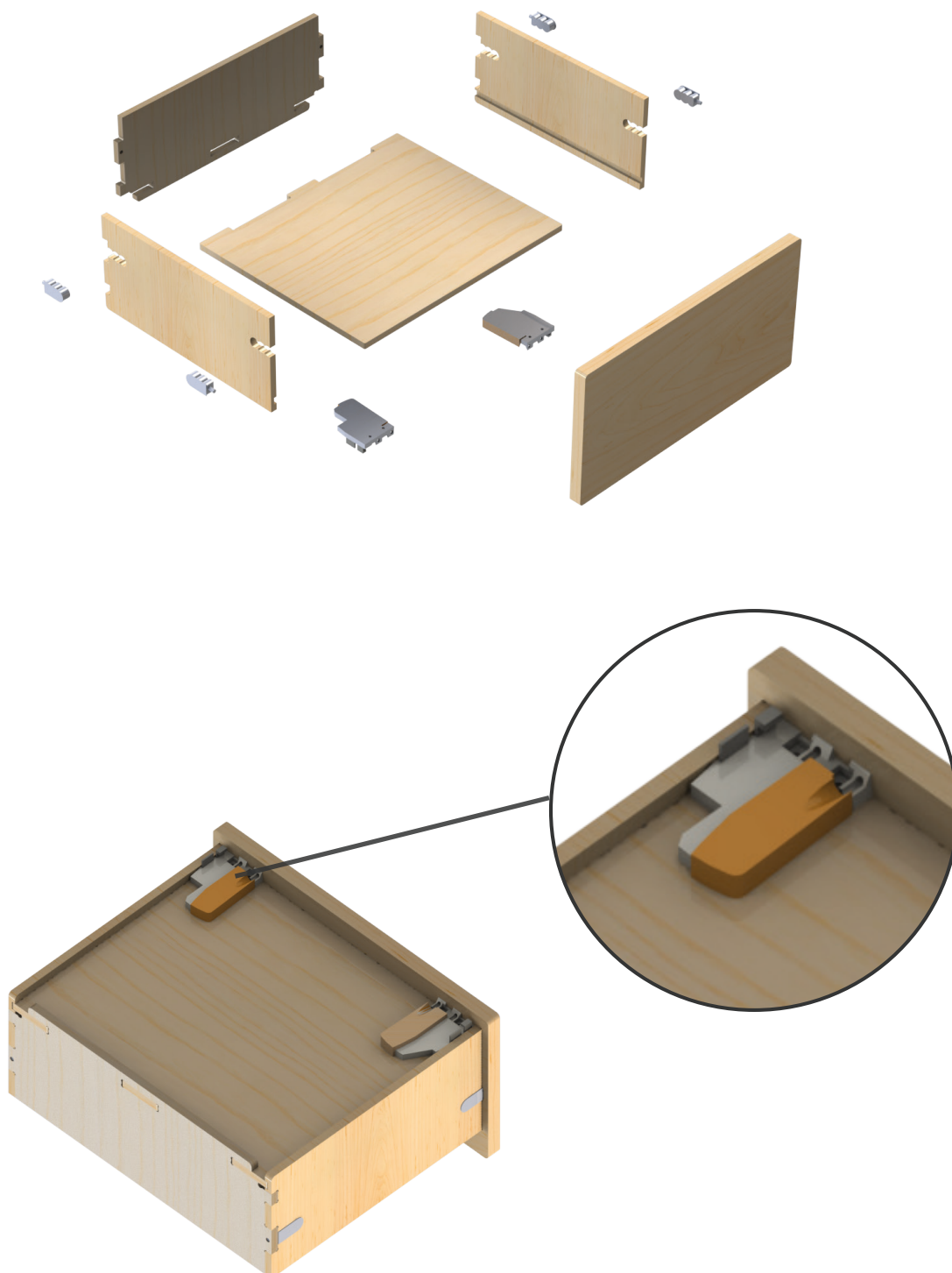

Viser en biais avec 2 vis 4x12 têtes bombées dans les trous prévus à cet effet.

Fixer les coulisses sur les joues avec les vis euro



20

Installation de la table avec le **kit table**

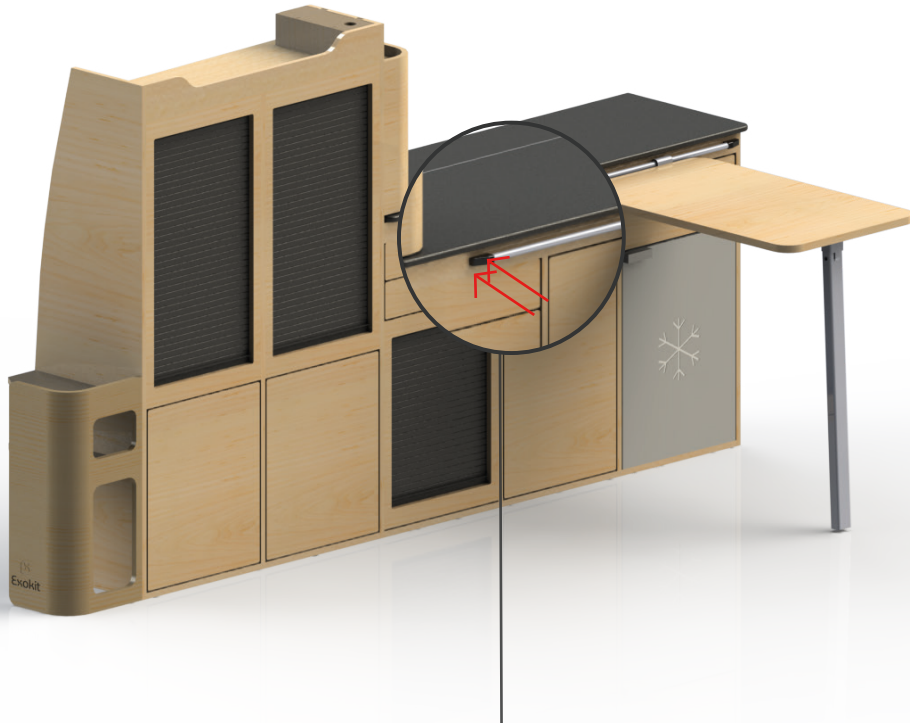

vis 4x25 pour fixer la barre au meuble (x6),
retirer la pièce centrale sur ressorts

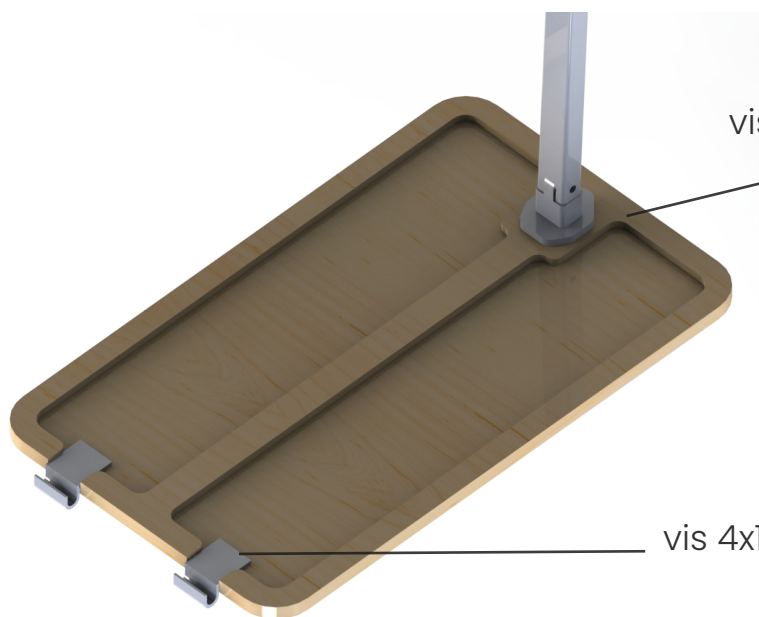

vis 4x16 pour fixer le pied (x5 vis)

vis 4x12 pour les accroches (x8 vis)

**Pour toutes questions n'hésitez pas
à nous contacter :**



10 Quai Armez 22000 Saint-Brieuc



02 90 90 18 42



contact@exokit-van.com



@exokit_van



Exokit-van



Exokit van



exokit-van.com







Exokit van



Prix révisable sans préavis - Photos et plans non contractuels - Re-
production interdite - RCS Saint-Brieuc 891418998 - Exokit SAS au
capital de 10 000€ - Hello Print

Votre partenaire :

-  @exokit_van
-  Exokit van
-  exokit-van.com
-  Exokit van
-  Exokit-van